

FBN-2TH Cotton Swab Machine (2000PCS/MIN SPEED)

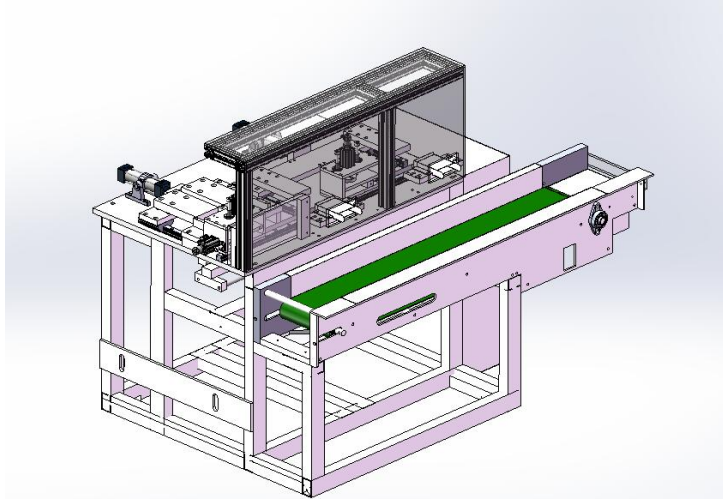

Right now we update the packing table:



Model	FBN-2TH
Max.Speed	2000pcs/min
Damageable parts	1.Notch heating tube 2.Belt spring 3. Brush 4.Glue tube
Power supply	380V 3Phase 50hz (220V 3Phase 60HZ customizable)
Drying type	closed type drying oven, economical and effective
Power consumption	13.5kw/hour
Suitable cotton sliver	1.5gram per meter
Suitable stick size	Length: 70mm (±2) ; Diameter: 2.0 --2.5mm
Type of cotton swab	Single head、 Double head
Suitable stick	Plastic、 Paper、 Wooden、 Bamboo
Manner of packing	Bag、 Round can、 Square box and so on
Machine size	9.0 * 1 * 1.7 meter
Machine weight	2100KG

All of our cotton swab machine are including making, drying and packing in one machine.











Feature:

- mould: high-precision stainless steel material. average service life up to 8--10 years.
- Electrical parts: high quality brand, Stable and durable. see below chart.
- Surface: high quality stainless steel. Beautiful and easy to clean.
- Operation panel: high quality and modern design. Easy to operate.

Electrical configuration list 配置单

No.	Name 名称	Origin 产地	Maker 品牌	Photos 图片	Notes 备注
1	PLC 可编程控制器	France 法国	Schneider Electric 施耐德电气		
2	Touch Screen 触摸屏	France 法国	Schneider Electric 施耐德电气		
3	Servo motor & Servo drive 伺服电机和驱动	France 法国	Schneider Electric 施耐德电气		
4	Temperature Control module 温控模块	France 法国	Schneider Electric 施耐德电气		
5	Inverter 变频器	Taiwan 台湾	Schneider Electric 施耐德电气		
6	Intermediate Relays 中间继电器	France 法国	Schneider Electric 施耐德电气		

7	Thermal Relays 热继电器	France 法国	 Schneider Electric 施耐德电气		
8	Switch 开关	France 法国	 Schneider Electric 施耐德电气		
9	Circuit breaker 断路器	France 法国	 Schneider Electric 施耐德电气		
10	Solenoid valve 电磁阀	Japan 日本			
11	Air cylinder 气缸	Japan 日本			
12	Filter 油水过滤器	Japan 日本			

13	Magnetic switch 磁性开关	Japan 日本			
14	Barometer 气压表	Japan 日本			
15	Hand rotary valve 手转阀	Japan 日本			
16	Distance Sensor 光电开关	Japan 日本	 欧姆龙		
17	Solid state relay 固态继电器	Taiwan 台湾			
18	Accurate rail 精密导轨	Taiwan 台湾	 Linear Motion Products & Technology		

Remark: The above configuration is subject to change without notice
以上配置如有更改，恕不通知

Offer:

FOB Ningbo port:

39000USD (Taiwan "AIRTAC" Pneumatic parts)

45000USD (Japan "SMC" Pneumatic parts)